

User Guide

# Pack controller Type **AK-PC 551**

Capacity control for double suction group compressor rack  
**SW Ver. 1.7**



## Contents

1. Introduction .....	3
2. Suction Group .....	4
3. Condenser.....	5
4. Safety functions .....	6
5. Display overview .....	7
6. Set-up overview.....	8
7. Menu.....	9
8. Connections used in “Quick configurations” .....	21
9. Alarm list.....	23
10. Connections .....	25
11. Data.....	27
12. External display.....	27
13. Ordering .....	28
14. Mounting /Dimensions.....	28

## 1. Introduction

### Application

The controller is used for capacity regulation of compressors and condensers in small refrigeration applications. A maximum of 8 compressors and one condenser can be regulated. For example:

- One suction group + one condenser group
- Two suction groups + one shared condenser (max. 4 + 4 steps)
- One compressor group, max. 8 steps
- One condenser group, max. 8 steps

### Advantages

- Energy savings via:
  - Optimisation of suction pressure
  - Night time increase
  - Floating condensing pressure
  - Load limitation

### Input and output

There are a limited number of available inputs and outputs. For each signal type, though, the following can be connected:

- Analogue inputs, max. 8 pcs.  
Signal from pressure transmitters, temperature sensors, voltage signal, etc.
- Digital inputs, max. 8 pcs.  
Signal from automatic safety control, day/night signal, etc.
- Relay outputs, max. 6 pcs.  
Connection of compressors, condenser fans
- Solid state outputs, max. 2 pcs.
  - Control of capacity valve on a Copeland digital scroll
  - Control of unloader on a Copeland stream compressor.
  - Control of both unloaders on a Bitzer CR11
 If the outputs are not used for these functions, they can be used as ordinary relay outputs
- Analogue outputs, max. 4 pcs. (3 can be used by the application)  
Speed control of compressors or condenser fans.

### Operation

The daily operation can be set up directly on the controller or via an external display device. During set-up, the display images will be adjusted so that only the relevant images are opened for additional setting and end-user operation. The operation is password protected, and three levels of access can be granted. The controller contains several languages. Select the preferred language at start-up.

### Data communication

The controller has built-in modbus data communication, and it can be connected to an AK-SM 800 type system device.

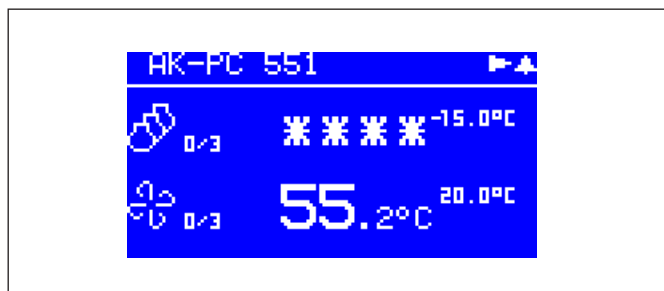
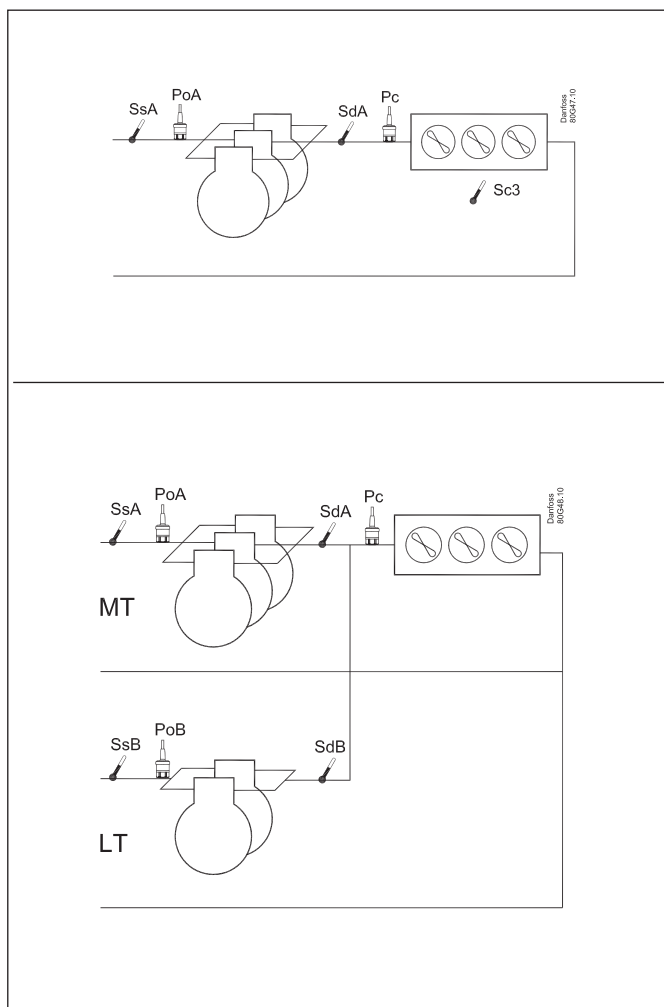

## 2. Suction Group

### Compressor types

The following types of compressors can be used for regulation:

- Single-step compressors (one can be speed-regulated)
- Compressor with unloaders
- Scroll compressors (one can be a digital scroll)
- Copeland Stream compressor with one unloader (4 cylinders)
- Bitzer CRII compressor with two unloaders (4-cylinders)

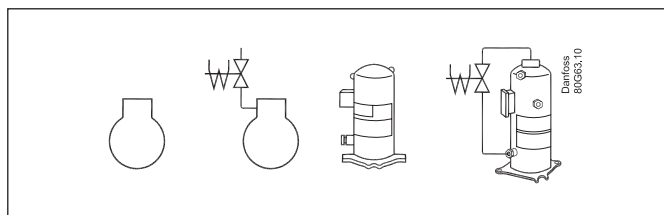

### Capacity distribution: Cyclical operation (FIFO)

All compressors are of the same type and size, except the lead compressor if present. The compressors cut in and cut out in accordance with the "First In First Out" principle (FIFO) to equalise operating hours between the compressors. The lead compressor will always be cut in first, and the variable capacity is used to fill capacity gaps between the subsequent steps.

#### Timer restrictions and safety cut outs:

If a compressor is prevented from starting because it is "hanging" on the restart timer or is safety cut out, this step is replaced by another compressor.

### Capacity regulation

The cut-in capacity is controlled by signals from the connected pressure transmitter/temperature sensor and the set reference. Set a neutral zone around the reference.

In the neutral zone, the regulating compressor controls the capacity so that pressure can be maintained. When it can no longer maintain the pressure within the neutral zone, the controller will cut out or cut in the next compressor in the sequence. When further capacity is either cut out or cut in, the capacity from the regulating compressor will be modified accordingly to maintain the pressure within the neutral zone (only where the compressor has variable capacity).

- When the pressure is higher than the "reference + a half neutral zone", cut-in of the next compressor (arrow up) is permitted.
- When the pressure is lower than the "reference - a half neutral zone", cut-out of a compressor (arrow down) is permitted.
- When the pressure is within the neutral zone, the process will continue with the currently activated compressors.

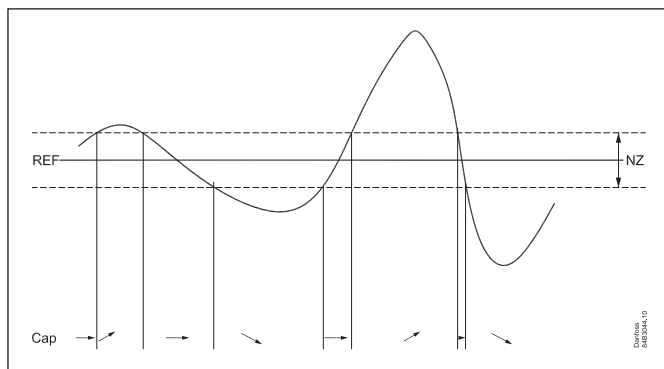

### Control sensor

Normally, a suction group is controlled based on a signal from the Po pressure transmitter.

If control on a brine, the S4 sensor must be the control sensor. The Po pressure transmitter must also be installed, as it is used for frost protection.

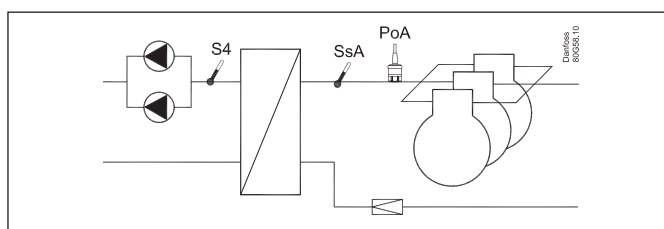

### The reference

At set or variable reference can be used for regulation. For example, the variable reference can be used for a night time increase or Po optimisation. Enter a set point here so that a contribution from the Po optimisation or night time increase is added. This contribution can raise or lower the reference, as determined by the momentary cooling need.

To limit the reference from values that are too high or too low, set a max. and min. limit.

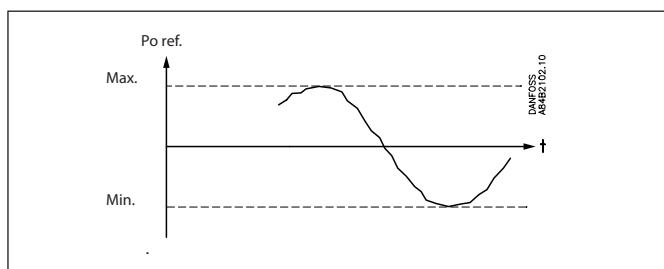

### Load shedding

When the load shedding function is activated, the maximum permissible compressor capacity will be limited to the set limit. In this way, the total electrical load in the store is limited.

The threshold value may not be set lower than the compressor's lowest capacity step/"Start speed".

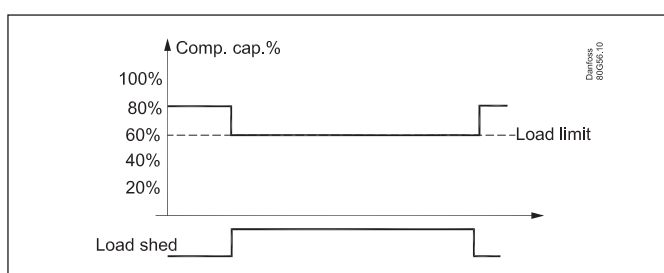

### 3. Condenser

#### Fan control

The fans can be controlled incrementally using the controller's relays, or they can be speed-controlled via the controller's analogue output. Speed control can be via a frequency VLT-type transformer. If the fans have EC motors, the 0 – 10 V signal can be used directly.

Step and speed simultaneously. (Parallel signals in step with each other.) This function is primarily used to control a frequency converter, but if the frequency converter fails, external wiring will switch over to step control.

During night operation, the noise level of the fans can be kept down. This is done by limiting the cutin capacity. For speed control, keep the number of revolutions low. Omit step cutin for step-by-step activation.

#### VSD Max speed limitation

The AO for fans are limited to VSD Max speed to decrease the noise level.

VSD Max. speed and night limitations are bypassed if safety functions Sd max. and Pc max. start to function.

#### Control

Regulation is carried out based on a signal from the Pc pressure transmitter or an S7 media temperature sensor. The signal is compared with the regulation reference.

The regulation reference can originate from one or more of the following functions:

- Fixed reference
- Variable reference, which follows the outdoor temperature. When the outdoor temperature drops, the reference will drop by a corresponding amount. This variable reference requires the installation of an Sc3 outdoor temperature sensor. The sensor must be positioned so that it registers the correct outdoor temperature. In other words, it must be shielded from direct sunlight and located near the airway of the condenser. This regulation requires setting a min. and max. reference, so that the regulation process is kept within the given limits.
- Increase the reference for heat recovery. Here the reference is raised to a fixed value when a signal is received on a DI input. The reference value can be higher than the set max. reference. When the temperature of the heat recovery has been reached and the DI signal disappears, the reference will drop once again, though it will do so over the course of a few minutes to prevent abrupt changes in the reference.

#### Media temperature

If controlling a media temperature, the control sensor must be set to S7. This temperature sensor must be located in the desired medium.

The Pc pressure transmitter must also be installed. It is used for high-pressure monitoring.

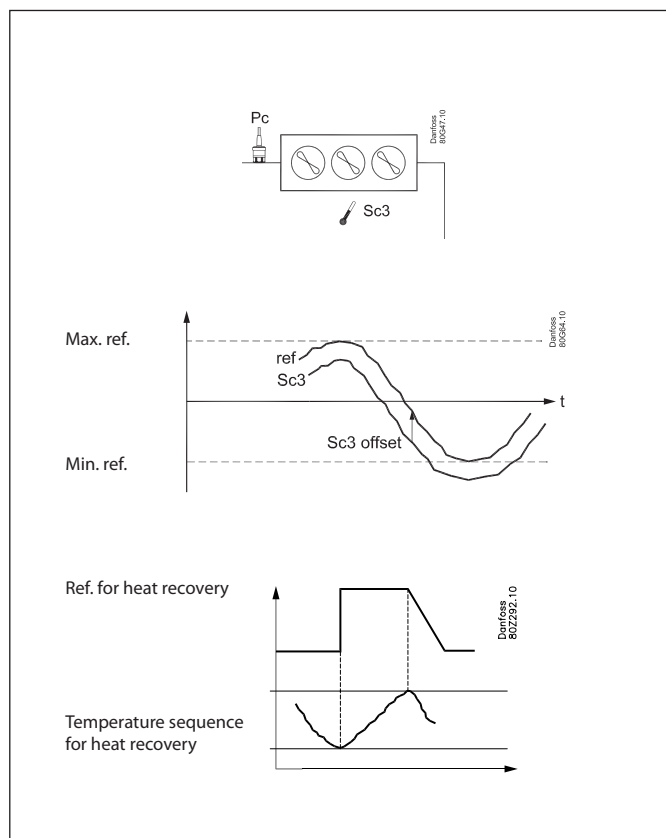
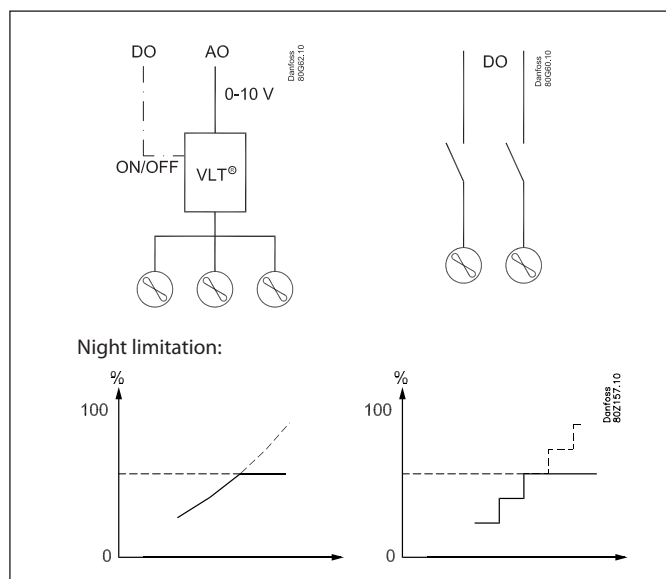

## 4. Safety functions

### Min./max. suction pressure Po

The suction pressure is recorded continuously. If the measured value falls below the set minimum limit, the compressors will immediately cut out. If it exceeds the max. value, an alarm will be generated once the time delay has elapsed.

### Max. condensing pressure Pc

If the condensing pressure reaches the upper permissible value, the controller will connect all condenser fans to keep the pressure down. At the same time, a portion of the compressor capacity will be disconnected. If the pressure remains near the threshold value, even more compressors will be disconnected. All compressors will be disconnected immediately if the threshold value is exceeded.

### LP switch

On/off signal on a DI input  
If a signal is received, all compressors will immediately be stopped.

### HP switch

On/off signal on a DI input  
If a signal is received, all compressors will immediately be stopped. Fan capacity will increase depending on how much the Pc measurement exceeds the reference.

### Min./max superheating via Ss measurement

Temperature sensor on an AI input.  
If superheating is higher or lower than the set limits, an alarm will be generated once the time delay has elapsed.

### Max. discharge gas temperature Sd

Temperature sensor on an AI input.  
A signal can be received from a Pt 1000 Ohm sensor on the pressure pipe.

- Common Sd for the whole compressor group  
If the temperature nears the set max. temperature, the capacity of the compressor will be reduced
- Compressor Sd  
if it is an Sd from a Copeland digital scroll, a Copeland stream or Bitzer CRII the capacity will be increased so that the compressor can cool down itself).

The compressors will be stopped if the temperature nears the set max. temperature value.

### Sensor failure

If lack of signal from one of the connected temperature sensors or pressure transmitters is registered an alarm will be given.

- In the event of a Po error, regulation will continue with a set capacity in daytime operation (e.g. 50%), and a set capacity in night operation (e.g. 25%), but with a minimum of one step.
- In the event of a Pc error, the condenser capacity that corresponds to how much compressor capacity is connected will cut in. Compressor regulation will remain normal.
- When there is an error on the Sd sensor the safety monitoring of the discharge gas temperature will be discontinued.
- When there is an error on the Ss sensor the monitoring of the superheat on the suction line will be discontinued.
- In the event of an error on the outdoor temperature sensor, Sc3, the permanent setting value will be used as a reference.
- In the event of an error on the S4 sensor, regulation will continue with the Po signal, but the reference will be lowered by 5 K.
- In the event of an error on the Saux sensor, the thermostat output will go to the rest position.

**Note:** A faulty sensor must be OK within 10 minutes before a sensor alarm is cancelled.

A sensor alarm can be reset manually by pushing the "X-button" for 2 s when the alarm is shown in the display "Active alarms".

### General DI alarms

On/off signal on a DI input  
The regulator contains three general alarm inputs, to which alarm text and delay times can be connected.  
Alarm and text will appear when the delay time has elapsed.

### General thermostat

It is possible to install one general thermostat if there is a relay output and an analogue input available.

### Injection ON

The function is used to interrupt refrigerant injection to evaporators when no compressors are available to start.

The pack controller will keep the "injection ON" signal, when a compressor is running, but also when all compressors are stopped but can be started.

Only when none of the compressors are allowed to start due to:

- pending restart timer
- minimum off timer
- safety cut-out or common safety cut-out and the suction saturation temperature exceeds 2 K above the Neutral Zone for more than 120 s (default), the "injection ON" signal is switched OFF and case controller are stopped.

The communication with case controller can use a DI or Network signal.

## 5. Display overview

### End-user overview

The images in this daily user interface will depend on how the set-up is made. They will illustrate what is regulated. For example: One or two suction groups, one condenser group, or a combination. See examples below:

1 suction groupe				
1 condenser group				
2 suction groups				
2 suction groups and 1 condenser group				

Each of the four rows above is continued with three additional displays. The arrow in the top corner of the display shows the way to the next display in the same area of operation. By clicking the right arrow you can see these three displays:

<b>Active alarms</b> 	<b>Cleared Alarms</b> 	<b>Information on the controller</b> 
--------------------------	---------------------------	--



When an alarm is sent from the controller, you must advance to this display to see the alarm text.

## 6. Set-up overview

There are three ways in which the controller can be set up. Select the one that is easiest for you: either "Wizard", "Quick settings" or a review of "all parameters".

Start screen upon delivery



Hold "Enter"  $\leftarrow$  down for 2 seconds to come to password entry



The default password upon delivery is 300. Use the arrow keys to set the password. End by pressing "Enter"  $\leftarrow$

### Operating principles

1. Select position using arrow keys
2. Select using "Enter"  $\leftarrow$
3. Use the "X" to return

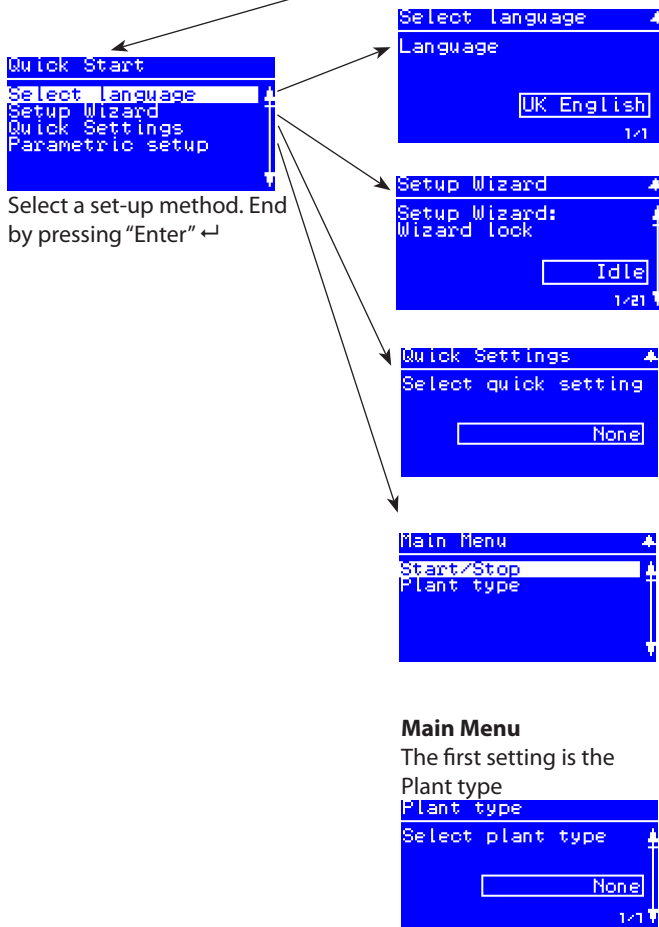
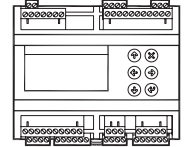

Select a set-up method. End by pressing "Enter"  $\leftarrow$



### Wizard

Here you will be led through a series of settings, after which the controller will be ready for start. Image 1 of 28 is displayed here.

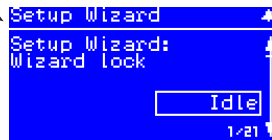

### Quick

Select from the different combinations of compressors and fans here. Also see the overview on pages 18 and 19.

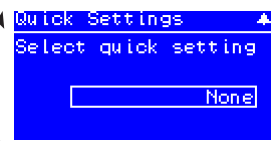

- 3CDA + 2CB + FS
- 2CDA + 2CB + 3F
- 3CSA + 2CB + FS
- 2CSA + 2CB + 3F
- 4CA + 3CB + FS
- 3CA + 2CB + FS
- 2CA + 2CB + 3F
- 4CDA + FS
- 3CDA + FS
- 3CDA + 3F
- 2CDA + 2F
- 4CSA + FS
- 4CA + FS
- 4CA + 4F
- 3CSA + FS
- 3CA + FS
- 3CA + 3F
- None

### Example:

3CDA + 2CB + FS =  
3 Compressors,  
one Digital,  
suction group A  
+  
2 Compressors,  
suction group B  
+  
one fan,  
Speed controlled

### Main Menu

The first setting is the

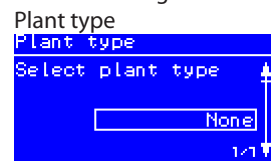

When the Plant type has been selected, it will allow several settings to be made.

For example:



Continue to the next menus.

All settings are explained on the pages that follow.

The following options are available here:

- 2 Comp + 1 Cond = suction group A + B and condenser
- Comp. + Cond. = suction group A and condenser
- Condenser = condenser only
- Compressor = suction group A only
- None



## 7. Menu

SW: 1.7

Start/stop		
<b>Main switch</b>	<p><b>Main switch</b> Start and stop regulating here. The configuration settings will require that regulating is stopped. If you try to enter a configuration setting when regulating has started, the controller will ask if regulating should be stopped. When all settings have been made and the main switch is set to "ON", the controller will enable the display of the various measurements. Regulation will start. (If an external main switch has been defined, it must also be "ON" before regulating starts.)</p>	On / Off
<b>Extern Main switch</b>	<p><b>External main switch</b> It is possible to connect an external switch which can be used to start and stop regulating. Both the internal and external main switch must be ON before regulating starts. An external main switch can be defined in the menu "Plant type" - "Main switch via DI".</p>	
Plant type		
<b>Select Plant type</b>	<p><b>Plant settings:</b> The following must be regulated:</p> <ul style="list-style-type: none"> <li>• Compressor group</li> <li>• Condenser group</li> <li>• One compressor group (A) + One condenser group</li> <li>• Two compressor groups (A) and (B) + One condenser group</li> </ul>	Fac: None
<b>Refrigerant type</b>	<p><b>Refrigerant setting</b> Before refrigeration is started, the refrigerant must be defined. You may choose between the following refrigerants: R12, R22, R134a, R502, R717, R13, R13b1, R23, R500, R503, R114, R142b, user defined, R32, R227, R401A, R507, R402A, R404A, R407C, R407A, R407B, R410A, R170, R290, R600, R600a, R744, R1270, R417A, R422A, R413A, R422D, R427A, R438A, R513A (XP10), R407F, R1234ze, R1234yf, R448A, R449A, R452A. Warning: Wrong selection of refrigerant may cause damage to the compressor. Other refrigerants: Here Setting "user defined" is selected and then three factors - fac1, fac2 and fac3 and temperature glide (if necessary).</p>	Fac: None
<b>Unit of setpoints</b>	<p>Device for controlling compressor and condenser Select pressure or saturation temperature. (Can be set during initial set-up and must <b>not</b> be subsequently changed.)</p>	Temp. / press Fac: Saturated
<b>Night signal via DI</b>	<p><b>Night time operation via DI signal</b> Define an external switch here, so that the regulation reference can be raised and lowered externally. 1. Set the function to "Yes" 2. Go to I/O configuration and select an available digital input. Set this input to "Night condition" 3. Next, define whether the function is to be active when the signal is ON, or when it is OFF.</p>	<b>DI-demand</b> No / Yes Fac: No
<b>Main Switch via DI</b>	<p><b>Main switch via DI</b> Define an external main switch here, so that regulation can be started and stopped externally. 1. Set the function to "Yes" 2. Go to I/O configuration and select an available digital input. Set this input to "Main switch" 3. Next, define whether the function is to be active when the signal is ON, or when it is OFF.</p>	<b>DI-demand</b> No / Yes Fac: No
<b>Mains frequency</b>	<p><b>Frequency</b> Set the net frequency</p>	50 Hz / 60 Hz Fac: 50 Hz
<b>Alarm output</b>	<p><b>Alarm relay</b> Define an alarm relay here that will be activated in the event of an alarm. 1. Select the alarm priority that will activate the relay</p> <ul style="list-style-type: none"> <li>• No relay</li> <li>• Critical alarm</li> <li>• Severe alarm</li> <li>• All alarms</li> </ul> <p>2. Go to I/O configuration and select an available digital output. Set this output to "Alarm" 3. Next, define whether the relay will be active (pulled) when the alarm is ON, or when it is OFF.</p>	<b>DO-demand</b> Fac: No relay
<b>Alarm buzzer</b>	<p><b>Alarm sound</b> Here the sound generator can be defined to emit a sound in the event of an alarm. Select which alarm priority will activate the sound generator:</p> <ul style="list-style-type: none"> <li>• No buzzer</li> <li>• Critical alarm</li> <li>• Severe alarm</li> <li>• All alarms</li> </ul> <p>(In the event of an alarm, the sound generator can be stopped by moving across the active alarm screen; see page 6)</p>	Fac: No buzzer

Suction A			
	Control status	Regulation status	
	Control status	Read the status of the control circuit here e.g.: <ul style="list-style-type: none"> <li>• No comp. - No compressor capacity available</li> <li>• Normal ctrl - Normal control</li> <li>• Alarm Comp. - Cannot start compressor due to alarm condition</li> <li>• ON timer - Cannot stop compressor due to ON timer restriction</li> <li>• Start timer - Cannot start compressor due to Start timer restriction</li> <li>• Normal ctrl - Normal control - no compressor staging</li> <li>• Inj. On Delay - Waiting for injection on delay to expire</li> <li>• Cascade</li> <li>• 1st comp del - First compressor run timer</li> <li>• Pump down - Last compressor running to pump down limit</li> <li>• Sensor error - Emergency control due to sensor error</li> <li>• Load shed - Load shedding function active</li> <li>• Sd High - Capacity control in High Sd safety prevention mode</li> <li>• Pc High - Capacity control in High Pc safety prevention mode</li> <li>• Manual ctrl - Capacity control in manual mode</li> <li>• Main switch OFF - OFF</li> </ul>	
	Actual zone	You will be able to see how the regulation is in relation to the reference here: P0 error: No regulation - Zone: The desired pressure is below the reference value NZ: The pressure is in place in relation to the reference value + Zone: The desired pressure is above the reference value	
	Control temp.	The current value of the regulation sensor can be read here	
	Reference	The total regulation reference can be read here	
	Running capacity	Here the connected capacity can be read as a % of total capacity	
	Requested capacity	Here the preferred connected capacity can be read as a % of total capacity	
	No. of running comp.	The number of compressors in operation can be read here	
	PoA Pressure	The measured pressure for the PoA pressure transmitter can be read here	
	ToA Saturated temp.	The measured PoA pressure converted to temperature can be read here	
	MC PoA offset	The size of a reference displacement on Po required from the system unit (suction pressure optimisation function) can be read here	
	Pc Pressure	The measured pressure for pressure transmitter Pc can be read here	
	Tc Saturated temp.	The measured Pc pressure converted to temperature can be read here	
	Day / Night status	The status of the day/night function can be read here	
	Load shed	The status of the load shed function can be read here	
	Injection ON A	The status of the injection ON signal sent to the evaporator controllers can be read here	
	MC Load Shedding	The status of the load shed signal received from the system device can be read here	
	MC Night Setback	The status of the night increase signal received from the system device can be read here	
	<b>Control settings</b>	<b>Regulation settings</b>	
	Control mode	Regulation type The regulation is normally set to "Auto", but it can be changed to "Off" or "Manual". When setting to "Manual", a forced capacity setting can subsequently be entered in %.	MAN / OFF / AUTO Fac: AUTO Min: 0 % Max: 100%
	Setpoint	Enter the set point for the regulation (regulation reference = set point + different offsets) here An offset can originate from a night increase signal or from an override function on the system device.	Min: -80°C (-1.0 bar) Max: 30°C (50 bar) Fac: -15°C (3.5 bar)
	Neutral zone	Set the neutral zone around the reference here. Also see the illustration on page 3.	Min: 0,1 K (0.1 bar) Max: 20 K (5.0 bar) Fac: 6 K (0.4 bar)
	Night offset	If necessary, set the value by which the reference will be raised at night. Keep the setting at 0 if regulating with Po optimisation from a system device.	Min: -25 K (-5.0 bar) Max: 25 K (5.0 bar) Fac: 0 K (0.0 bar)
	Max Reference	Set the highest permissible regulation reference here	Min: -50°C (-1.0 bar) Max: 80°C (50.0 bar) Fac: 80°C (40.0 bar)
	Min Reference	Set the lowest permissible regulation reference here	Min: -80°C (-1.0 bar) Max: 25°C (40.0 bar) Fac: -80°C (-1.0 bar)
	PI control selection	Set how quickly the PI regulation must react here: 1 = slowly, 10 = very quickly. (For "Custom" setting 0, the special settings options will open, i.e. Kp, Tn and time settings around the neutral zone. These options are only for trained staff.)	Min: 0 (custom) Max: 10 Fac: 5
	Gain factor Kp	The amplification factor, Kp (can only be seen and set when the previous menu is set to "0")	
	Integration time Tn	Integration time Tn (see above)	
	+ Zone rate of change	Change coefficient for + zone (see above)	
	- Zone rate of change	Change coefficient for - zone (see above)	

	First step runtime	At start-up, the cooling system must have time to cool down before PI regulation takes over the regulation role and can cut in the next compressor. Set the time before the next compressor may be started here.	Min: 0 s Max: 300 s Fac: 120 s
	Pump down	Pump-down function To avoid too many compressor starts/stops at a low load, it is possible to define a pump-down function for the last compressor. In this case, the compressor will be cut out when the current suction pressure is down at the set "Pump-down limit Po". (The setting must be greater than the safety limit for low suction pressure "PoA Min Limit")	Yes /No Fac: No  Min: -80°C (-1.0 bar) Max: 30°C (50.0 bar) Facb: -40°C (0.3 bar)
	Load shed limit	Capacity limitation at "low shed signal" Set how much compressor capacity can be cut in when a signal is received from either a DI input or a system device via data communication.	Min: 0 % Max: 100% Fac: 100%
	Emergency cap. day	Emergency capacity in the event of a malfunction of the regulation sensor (suction pressure sensor) Set the desired capacity that will apply during daytime operation. (If the S4 media temperature sensor becomes damaged/defective, use Po for regulation.)	Min: 0 % Max: 100% Fac: 50%
	Emergency cap. night	Emergency capacity in the event of a malfunction of the regulation sensor (suction pressure sensor) Set the desired capacity that will apply during night operation. (If the S4 media temperature sensor becomes damaged/defective, use Po for regulation.)	Min: 0 % Max: 100% Fac: 25%
	Comp. start delay	Delay of compressor start after forced closing of expansion valves (at the end of a forced close signal) The delay will result in the system device receiving a start signal for all the evaporator controls involved before the first compressor is started.	Min: 0 s Max: 180 s Fac: 30 s
	Injection OFF delay	Delay of the forced closing of expansion valves, if the controller calls for cut in of compressors, but the compressors are in a locked situation and therefore cannot start.	Min: 0 s Max: 300 s Fac: 120 s
	<b>Configuration</b>	<b>Configuration</b>	
	Control sensor	Select the regulating sensor for the suction circuit: • Pressure transmitter Po • Media temperature sensor S4 (brine regulation). (Po is used for safety)	<b>AI-demand</b>  Po / S4 Fac: Po
	Compressor mode	Set the type of compressor to be used for regulation: • Multi all:*****) All compressors have unloaders • Multi + Single:*****) First compressor has unloaders. The remaining ones are one-step units • Speed+Multi: ****) First compressor is speed-controlled. The remaining ones are with unloaders. • Speed+Single: ****) First compressor is speed-controlled. The remaining ones are one-step units • CR114+Multi **) First compressor is CR114 compressor. The remaining ones are with unloaders • CR114+Single **) First compressor is CR114 compressor. The remaining ones are one-step units • Stream 4+Multi: **) First compressor is a stream compressor. The remaining ones are with unloaders • Stream 4+Single: **) First compressor is a stream compressor. The remaining ones are one-step units • Digital scroll: *) First compressor is a digital scroll. The remaining ones are one-step units • Single-step only: All are one-step compressors • None:	<b>DO-demand / AO-demand</b>  Fac: Single step only
	No. of compressors	Set the number of compressors on the suction circuit This is a total amount. (If both suction groups are selected, the max. number will be 4 for A and 4 for B.)	<b>DO-demand</b>  Min: 1 Max: 8 Fac: 0
	Lead comp. size	Set the nominal compressor capacity for the first compressor (it is defined under "Compressor mode") That is, the capacity of either a "Digital scroll", "Stream", "Variable speed CR11" or "First compressor with unloaders"	Min: 1 kW Max: 100 kW Fac: 1 kW
	Comp. size	Set the nominal compressor capacity of the other compressors For single-step only: All are of the same size, including the first. For unloader all: All are of the same size, including the first.	Min: 1 kW Max: 100 kW Fac: 1 kW
	VSD Min. speed	***: For speed Min. speed at which the compressor will cut out	Min: 10 Hz Max: 60 Hz Fac: 30 Hz
	VSD Start speed	***: For speed Minimum speed at which the compressor will start (must be set to a higher value than "VSD Min. speed")	Min: 20 Hz Max: 60 Hz Fac: 45 Hz
	VSD Max speed	***: For speed Highest permitted speed for compressor	Min: 40 Hz Max: 120 Hz Fac: 60 Hz

	PWM period time	*, **: For "Scroll" and "Stream" Set the period time for the unloader valve (on time + off time)	Min: 10 s Max: 20 s Fac: 20 s
	CRIL Period time	**: For CRIL Set the period time for the unloader valve (on time + off time)	Min: 10 s Max: 20 s Fac: 60 s
	Comp. 1 min cap.	*: For scroll and CRIL Minimum capacity in the time period (without a minimum capacity the compressor will not be cooled)	Min: 10% Max: 50% Fac: 10%
	Comp. 1 start cap	*: For scroll and CRIL Start capacity: the compressor will only start when the capacity requirement reaches the value	Min: 10% Max: 60% Fac: 30%
	Comp. 1 Sd temp.	*, **: For "Scroll", "Stream" and CRIL Define whether the controller should monitor the discharge gas temperature Sd from the compressor (NTC 86K or Pt 1000 Ohm).	<b>AI-demand</b> No / Yes Fac: No
	Comp. 1 Sd max.	*, **: For Scroll, Stream, CRIL and <b>yes</b> to "Comp.1 Sd temp" Set the maximum Sd temperature	Min: 0°C Max: 195°C Fac: 125°C
	No.of unloaders	****: For compressor with unloaders Set how many unloaders there are on the compressor	<b>DO-demand</b> Min: 1 Max: 3 Fac: 1
	Comp. safety input	Compressor safety circuit Define whether a DI input should be reserved for registration of each compressor safety circuit	<b>DI-demand</b> Yes /No Fac: Yes
	LP switch via DI	Low pressure safety circuit Define whether a DI input should be reserved for registration of the signal from an LP switch	<b>DI-demand</b> Yes /No Fac: No
	Load shedding via DI	Load limitation Define whether a DI input should be reserved for registration of the signal from a power meter • None: • DI: Load limitation must follow a DI input • Night Mode: Load limitation must follow the status of the day/night signal. (The day/night signal can be received via a DI input, via time schedule or network.)	<b>DI-demand</b> Yes /No Fac: No
	Sd disch. gas temp.	Shared discharge temperature Define whether signals from a common Sd sensor on the suction line (Pt 1000) should be received	<b>AI-demand</b> Yes /No Fac: No
	Ss suction superheat	Monitoring of superheat Define whether a signal from a common Ss sensor on the suction line should be received	<b>AI-demand</b> Yes /No Fac: No
	Injection ON function	Stop injection into evaporators If the compressors are prevented from starting, stop injection into the evaporators. Here define whether the function should be active and how the signal should be communicated. No: The function is not used Network: The controller sends a signal to the system unit, which then forwards it to the evaporator controls Relay: The function reserves a relay that pulls in if all compressors are stopped. All evaporator controls must be wired to this signal from the relay.	<b>DO-demand</b> No /Network /Relay Fac: No
	<b>Compressor timers</b>	<b>Compressor timers</b>	
	Lead comp. Min ON	Min. On-time for first compressor Set a forced On-time here during which the compressor will remain in operation before it can be switched off again. The setting is to prevent incorrect operation. To prevent a compressor breakdown, the setting must be made in accordance with the requirements of the compressor supplier.	Min: 0 min Max: 60 min Fac: 0 min
	Lead comp. Min OFF	Min. Off-time for first compressor Set the forced Off-time during which the compressor must be off before it can be switched on again. The setting is to prevent incorrect operation.	Min: 0 min. Max: 30 min Fac: 0 min
	Lead comp. Restart	Min. period of time for re-starting the first compressor. Set the forced Off-time during which the compressor must be off before it can be switched on again. The setting is to prevent incorrect operation. To prevent a compressor breakdown, the setting must be made in accordance with the requirements of the compressor supplier.	Min: 1 min. Max: 60 min Fac: 4 min
	Lead comp. Safety delay	Delay time before compressor no. 1 cut out for reasons of safety The time begins when a signal is received on the DI input (configure the DI input via "Configuration" and "Comp. safety inlet").	Min: 1 min. Max: 10 min Fac: 1 min

	Comp. Min ON	Min. On-time for remaining compressors Set a forced On-time here during which the compressor will remain in operation before it can be switched off again. The setting is to prevent incorrect operation.	Min: 0 min. Max: 60 min Fac: 0 min
	Comp. Min OFF	Min. Off-time for remaining compressors Set the forced Off-time during which the compressor must be off before it can be switched on again. The setting is to prevent incorrect operation.	Min: 0 min. Max: 30 min Fac: 0 min
	Comp. Restart	Min. period of time for restarting remaining compressors Set the forced Off-time during which the compressor must be off before it can be switched on again. The setting is to prevent incorrect operation.	Min: 1 min. Max: 60 min Fac: 4 min
	Comp. Safety delay	Delay time before compressors cut out for reasons of safety The time begins when a signal is received on the DI input (configure the DI input via "Configuration" and "Comp. safety inlet").	Min: 1 min. Max: 10 min Fac: 0 min
	<b>Compressor status</b>	<b>Compressor status</b>	
	Comp. 1 Sd gas	Read the Sd temperature of the compressor here.	
	Comp. 1 status	Read the operating status for compressor 1 here. The following information may appear: Alarm - Alarm situation Main Sw. off - Compressor is stopped Manual ctrl. - Compressor is cut out on safety input (DI safety input) High Sd temp. - Stopped due to high Sd temperature Ready - Compressor is ready to start OFF timer - Compressor is waiting for Min OFF timer to expire Min. ON timer - Compressor is waiting for Min ON timer to expire Running - Compressor is running Disabled - Compressor has been taken out of operation (compressor service)	
	Comp. 2.....	The same function for the remaining compressors	
	<b>Compressor capacity</b>	<b>Compressor capacity</b>	
	Comp. 1 cap	Read the connected capacity of the compressor (0-100%) here	
	Comp. 2.....	The same function for the remaining compressors	
	<b>Compressor runhours</b>	<b>Compressor run hours</b>	
	Reset runtime/cycles	Reset all of the hour counters and start counters for the subsequent compressors here.	
	Comp.1 Runtime L	Read the total operating time of the compressor (in hours) here	
	Comp.2.....	The same function for the remaining compressors	
	<b>Compressor cycles</b>	<b>Compressor cycles</b>	
	Comp.1 Cycle total	Read the number of times the compressor has been started here	
	Comp.2.....	The same function for the remaining compressors	
	<b>Compressor service</b>	<b>Compressor service</b>	
	Comp.1 out of service	The compressor can be taken out of operation, so that the controller regulates without this compressor. No = Normal regulation Yes = Regulating is carried out without this compressor, and no alarms are generated by it.	Yes /No Fac: No
	Comp.2.....	The same function for the remaining compressors	
<b>Suction B</b>			
		Suction group B. Please see descriptions under suction group A (Bitzer CRII can not be used in suction group B.)	
<b>Condenser</b>			
	<b>Control status</b>	<b>Regulation status</b>	
	Control status	Here you can read the status of the condenser circuit, e.g.: • Main Sw. off - Main switch = OFF • Ready - Capacity control is ready • Running - Capacity control is in normal run mode • Capacity control is stopped because all compressors are stopped • Manual ctrl - Capacity control is set in manual control mode • High Pc/Sd - Capacity forced to 100% due to High Pc/High Sd prevention functions • Safety limit - Capacity forced to 100% due to external HP switch/HP safety/Sd safety limit violation • Night limit - Capacity control limited due to night silencer limitation	
	Control temp.	The current value of the regulation sensor can be read here	
	Reference	The total regulation reference can be read here	
	Running capacity	Here the connected capacity can be read as a % of total capacity	
	Requested capacity	Here the preferred connected capacity can be read as a % of total capacity	
	No. of running fans	The number of fans in operation can be read here	
	Tc Saturated temp.	The measured Pc pressure converted to temperature can be read here	
	Pc Pressure	The measured pressure for pressure transmitter Pc can be read here	
	S7 Media	Here the measured media temperature with sensor S7 can be read (only if S7 has been selected as the regulation sensor during "Fan configuration")	

	Sc3 air on cond.	The measured outdoor temperature with sensor Sc3 can be read here	
	Heat recovery status	Here the status of the heat recovery function can be read	
	HP safety switch	The status of the HP safety switch can be read here	
	<b>Control settings</b>	<b>Control settings</b>	
	Control mode	Regulation type The regulation is normally set to "Auto", but it can be changed to "Off" or "Manual". When setting to "Manual", capacity can then be forced set in %.	MAN / OFF / AUTO Fac: AUTO Min: 0 % Max: 100%
	Setpoint	Enter the set point for the condenser regulation here. Also set a value if regulating with a fluid reference (set point value used in the event of an outside temperature sensor error).	Min: -25°C (-1.0 bar) Max: 90°C (159 bar) Fac: 35°C (15.0 bar)
	Sc3 offset	Temperature offset for regulation with fluid reference. Regulation reference = Sc3 measurement + Sc3 offset	Min: 0 K Max: 20 K Fac: 6 K
	Min. reference	Set the lowest permissible regulation reference here	Min: -25°C (-1.0 bar) Max: 100°C (159 bar) Fac: 10°C (5.0 bar)
	Max. reference	Set the highest permissible regulation reference here	Min: -25°C (-1.0 bar) Max: 100°C (159 bar) Fac: 50°C (35.0 bar)
	Heat recovery SP	Temperature set point for heat recovery function (only when the function is selected during configuration)	Min: 20°C (-1.0 bar) Max: 90°C (159 bar) Fac: 50°C (30.0 bar)
	Heat rec. ramp down	Ramp-down of regulation reference after heat recovery Set how quickly the reference for condenser pressure should be made after heat recovery ends. Enter the change in degrees Kelvin per minute.	Min: 0,1 K Max: 100 K Fac: 1 K
	Capacity limit night	Capacity limitation at night The speed of the fans can be limited here when regulating using speed control. During step-by-step activation, the start of the step-by-step process is limited.	Min: 0 % Max: 100% Fac: 100%
	Gain factor Kp	Amplification factor for PI regulation If the Kp value is lowered, regulation runs more smoothly	Min: 0,5 Max: 50 Fac: 10
	Integration time Tn	Integration time for PI regulation If the Tn value is increased, regulation will run more smoothly	Min: 10 s Max: 900 s Fac: 180 s
	<b>Fan configuration</b>	<b>Configuration of fans</b>	
	Control sensor	Selection of regulation sensor: • Pc pressure transmitter • S7 media temperature sensor (Pc must be installed for safety monitoring)	<b>AI-demand</b>  Pc / S7 Fac: Pc
	Reference mode	Set the reference for regulation here • Fixed reference; the reference here will be the defined set point • Variable reference; the reference here will follow the outside temperature, which is measured with Sc3.	<b>AI-demand</b>  Setpoint / Floating Fac: Setpoint
	Capacity ctrl. mode	Set the way in which the fans should be controlled here • Variable; the fans are controlled by a 0-10 V signal from an analogue output. If it is defined in "VSD Start via DO", a relay will be able to start and stop the frequency converter. • Step; on/off control of fans will be via relays • Variable + step. The signals are parallel, so external wiring can switch over to step, e.g. if the frequency converter fails.	<b>AO-demand</b>  Step / Speed Fac: Step
	No. of fans	Enter the number of fans here. For step-by-step activation, select the number of relays. The relays will cut in/out sequentially, e.g. 123-321. For speed control, select 1 or higher. No relay is reserved, but the setting makes it possible to define the monitoring of fans.	<b>DO-demand</b>  Min: 0 Max: 8 Fac: 0
	Control type	Normally, PI-regulation is used, but this can be changed to a P-regulation if the design of the system necessitates this. • PI Ctrl: Regulation is carried out here with as little deviation between the reference and measurement as possible. • P-band ctrl: Capacity is cut in here after proportional regulation.	P / PI Fac: PI
	VSD Start speed	Set the start value of the frequency converter here. The value must be higher than the VSD min. speed value.	Min: 0% Max: 60% Fac: 35%
	VSD Min. speed	Set the minimum speed of the frequency converter here. If lower capacity is required, this minimum speed should be maintained all the way down to 0% capacity. At 0% capacity, the system stops completely.	Min: 0% Max: 40% Fac: 20%
	VSD Max. speed	Set the maximum speed of the frequency converter here. The maximum speed used under normal control. In case of high PC or high Sd then VSD maxspeed is ignored.	Min: 61% Max: 100% Fac: 80%

	VSD Start via DO	Define whether a relay should be connected to the frequency converter start/stop function here: • No: no relay • Yes: the relay pulls in when the frequency converter needs to be in operation.	<b>DO-demand</b>  Yes / No Fac: No
	Monitor fan safety	Define whether safety monitoring of the condenser fans should be performed. • None: no monitoring • Individual: a DI input is reserved for each fan • Common: a DI input that is common for all condenser fans is reserved .	<b>DI-demand</b>  Common /Individual Fac: None
	Fan at comp. OFF	Select the way in which the fans should be controlled when all the compressors have stopped. • Normal regulation: Fans to be controlled in compliance with normal regulation. • Energy-optimised: Fan capacity will be maintained at between 0 and 49% in a p-band of 5 – 15 K above reference.	Normal/Optimized Fac.: Normal
	Heat recovery via DI	Define whether a heat recovery cycle should be started with a signal on a DI input here. • No: No function • Yes: A DI input is reserved. When a signal is registered, the heat recovery function reference will become active.	<b>DI-demand</b>  Yes / No Fac: No
	<b>Fan status</b>	<b>Fan status</b>	
	Fan speed	Here a reading of the desired condenser fan capacity is provided in %	
	VSD start/stop	Fan operation (frequency converter) status can be read here	
	Fan 1	The status of relay 1 (step 1 or relay for frequency transformer) is indicated here	
	Fan 2.....	The status of relay 2, 3, etc. (step 2, 3, etc.) is indicated here	
	<b>Fan Runhours</b>	<b>Fan Run hours</b>	
	VSD Runtime total	The number of hours the fans have been in operation (frequency converter operation) can be read here	
	Fan 1 Runtime total	The number of hours fan relay 1 has been in the On-position (frequency transformer has been On) is indicated here	
	Fan 2.....	The same function for the remaining fans	
	<b>Fan cycles</b>	<b>Number of fans starting</b>	
	VSD cycles	The number of fan starts (frequency converter) can be read here	
	Fan 1 Cycles total	The number of times fan relay 1 has been in the On-position (frequency converter has been on) is indicated here The controller checks that the fan has been active within the last 24 hours. If not, it will be forced to start in 5 minutes, in rotation with the other fans.	
	Fan 2...	The same function for the remaining fans	
<b>Safety monitoring</b>			
	<b>PoA Min limit</b>	<b>Safety limits for min. PoA</b> If a low value is registered, all compressors will cut out	Min: -120°C (-1.0 bar) Max: 30°C (159 bar) Fac: -40°C (0.5 bar)
	<b>PoA Max alarm</b>	<b>Alarm limit for high PoA</b> If a high value is registered, an alarm will be generated If a higher value is registered during a load limitation, the load limitation will be cancelled until Po has returned to the reference.	Min: -30°C (-1.0 bar) Max: 100°C (159 bar) Fac: 100°C (5.0 bar)
	<b>PoA Max delay</b>	<b>Delay time for issuing a PoA max. alarm</b>	Min: 0 min. Max: 240 min. Fac: 5 min.
	<b>Superheat Min lim A</b>	<b>Alarm limit for insufficient superheating</b> (Superheating is measured in the suction line by PoA and SsA.)	Min: 0 K Max: 20 K Fac: 0 K
	<b>Superheat Max lim A</b>	<b>Alarm limit for excess superheating</b>	Min: 20 K Max: 80 K Fac: 80 K
	<b>Superheat delay A</b>	<b>Delay time before alarm is generated for insufficient or excess superheating</b>	Min: 0 min. Max: 60 min. Fac: 5 min.
	<b>SdA Max limit</b>	<b>Safety limit for max. SdA</b> At 10 K under the set value, the compressor capacity will be reduced, and the entire condenser capacity will cut in. If the threshold is exceeded, the entire compressor capacity will cut out.	Min: 0°C Max: 195°C Fac: 80°C
	<b>PoB Min limit</b>	<b>Same settings for a suction group B</b>	
	<b>PoB Max alarm</b>		
	<b>PoB Max delay</b>		
	<b>Superheat Min lim B</b>		
	<b>Superheat Max lim B</b>		
	<b>Superheat delay B</b>		
	<b>SdB Max limit</b>		

<b>Pc max limit</b>	<b>Safety limit for max. Pc</b> If Pc exceeds the value set here minus 3 K, the entire condenser capacity will cut in, and compressor capacity will be reduced by 1/3 for every 30 seconds. If Pc exceeds the threshold value, the entire compressor capacity will immediately cut out, and an alarm will be generated when the delay time expires.	Min: -1 bar Max: 159 bar Fac: 40 bar
<b>Tc Max limit</b>	<b>Safety limit for max. Tc</b> The above setting for Pc max. limit can be read as a temperature here.	-
<b>Pc Max delay</b>	<b>Time delay for Pc max. alarm</b> The alarm will only be generated when the time delay has elapsed.	Min: 0 min. Max: 240 min. Fac: 0 min.
<b>HP switch via DI</b>	<b>Signal from an HP switch</b> Define whether a signal is to be received on a DI input here. The status of the signal can be read, and an alarm can be linked to it. Once a signal is received, compressor capacity will cut out.	<b>DI-demand</b>  Yes /No Fac: No
<b>Safety restart time</b>	<b>Delayed start-up following safety cut-out</b> If a safety cut-out has occurred due to "Sd max. limit", "Pc max. limit" or "Po min. limit", the compressors must be kept stopped for a defined period of time. The amount of time can be set here.	Min: 0 min. Max: 60 min. Fac: 1 min.
<b>Sensor alarm reset</b>	<b>Reset alarm after sensor error</b> When a sensor error has occurred, an O.K. signal must be registered within a specified number of minutes before the controller resets the alarm. The regulation will be resumed as soon as the sensor signal is O.K.	Min: 0 min. Max: 30 min. Fac: 10 min.
<b>General functions</b>		
<b>Digital input alarms</b>	<b>General on/off alarm</b> Here you can define up to 3 alarms that are not related to the regulation function. When a signal is received on the input, the controller will generate an alarm, but only after the related delay time has elapsed. The alarm can be defined to be active for an on/off signal. An alarm text can be entered for the alarm. This text can be seen in the display and can be sent to a system device.  1. Define the appurtenant alarm text 2. Set the delay time for the alarm 3. Go to I/O configuration and select an available digital input. Set this input to "General alarm (no.)" 4. In the subsequent menu, define whether the alarm is to be active for an on/off signal.	
No. of DI alarm fct.	1. Define how many general alarms there should be	<b>DI-demand</b>  Min: 0 Max: 3 Fac: 0
DI1 Alarm text	The following alarm texts can be selected: • General alarm • High pressure alarm • Low pressure alarm • High temperature alarm • Low temperature alarm • Oil level alarm • Oil temperature alarm • Liquid level alarm • Leak detection alarm • Inverter fault	
DI1 Alarm delay	Delay time for the DI1 alarm	Min: 0 min. Max: 360 min. Fac: 5 min.
DI2....3	The same setting option for a DI2 alarm and a DI3 alarm.	
<b>Thermostat</b>	<b>General thermostat</b> One general thermostat can be defined. 1. Define the function 2. Go to I/O configuration and select an available analogue input. Set this input to "Saux thermostat" 3. Go to I/O configuration and select an available relay output. Set the output to "thermostat".	<b>AI-demand</b>  Yes / No Fac: No
Thermostat cut in	Here set the temperature value at which the thermostat will cut in	Min: -50°C Max: 150°C Fac: 5°C
Thermostat cut out	Here set the temperature value at which the thermostat will cut out	Min: -50°C Max: 150°C Fac: 10°C
Thermostat temp.	The current sensor temperature of the thermostat can be read here (But only once the sensor input has been defined and the main switch has been set to "On".)	-



System			
	<b>Display</b>	<b>Select views on the display</b>	-
	Language	Choose from the following languages: English, German, French, Danish, Spanish, Italian, Portuguese, Dutch, Russian, Polish, Czech, Turkish, Hungarian, Croatian, Serbian, Romanian	Fac: UK English
	Engineering units	Device Select SI or Imperial (when setting the compressor capacity with U.S. values).	SI / Imperial Fac: SI
	Pressure units	Pressure unit Select bar or PSIG	Bar / PSIG Fac: bar
	Temperature units	Temperature unit Select °C or °F.	°C / °F Fac: °C
	Time format	Time format Choose 12-hour or 24-hour format.	12 / 24 Fac: 24 h
	Screen saver time	Screen saver time If no buttons have been pushed for a specific period of time, the light in the display will be minimised. The light level will be restored upon renewed activity.	Min: 1 min. Max: 60 min. Fac: 1 min.
	User logout time	Log-off time If buttons have not been pressed within a specified period of time, the screen will return to the overview display. Afterwards, the user will have to log on again. If the time is changed, the new time will apply the next time the user logs in. If you log out here without waiting for the time-out period to elapse, go to the overview display and hold down the "X" button for 3 seconds.	Min: 1 min. Max: 60 min. Fac: 2 min.
	Display contrast	Adjust contrast	Min: 0 Max: 100 Fac: 30
	<b>Password</b>	<b>Access code</b> The settings in the controller can be protected with three levels of access codes. Level 1: End user settings, such as changing the weekly plan Level 2: Adjusting installer level Level 3: Configuration of system settings (configuration menu) The access code is a number between 001 and 999. <b>Note:</b> If the password is duplicated then logon is for the highest level user.	
	Password level 1		Fac: 100
	Password level 2		Fac: 200
	Password level 3		Fac: 300
	<b>Real time clock</b>	<b>Date and time</b> Used by weekly plan and alarm function.	Year, month, date Hours, minutes
	<b>Weekly schedule</b>	<b>Weekly plan</b> Set the opening and closing hours of the store here The times can be used to change the regulation reference for suction pressure and for lower fan speeds at night.	-
	Monday open	Time of opening, Monday	Hours, minutes
	Monday close	Time of closing, Monday	Hours, minutes
	Tuesday op.....	Times for remaining weekdays	-
	<b>Network</b>	<b>Network</b>	-
	Modbus Address	Set the address of the controller here if it is connected to a system device via data communication.	Min: 0 1 Max: 120 Fac: 1
	Baudrate	The system unit usually communicates with 38.4. If it is changed in the system unit to for example, "SLV" mode (19.2), setting must also be changed to 19.2 here in the controller.	Fac: 384
	Serial mode	The value must not be changed	Fac: 8E1
	<b>Reset to factory</b>	<b>Return to factory settings</b> If this function is set to "YES", all settings will be returned to factory default settings, and the alarm list will be cleared.	

I/O configuration		
<p>Here you can select functions for the individual inputs and outputs. To prevent faulty settings, only select functions that have been set up via the configuration menus for the suction groups and the condenser.</p> <p><i>For digital outputs</i>, define whether the function will be active for an activated or deactivated relay.</p> <p><i>For digital inputs</i>, define whether the function/alarm will be active for an interrupted or shut-off switch.</p> <p><i>For analogue outputs</i>, define whether the output signal should be 0 – 5 V or 0 – 10 V</p> <p><i>For analogue inputs</i>, define:</p> <p>Temperature sensors: Normally, the sensor type is a Pt1000 model, but for digital scroll/stream discharge gas temperature monitoring, an NTC 86K @ 25 °C can also be selected. Calibration value (+/- 10°C)</p> <p>Pressure sensors: Signal type: 0 – 20 mA, 4 – 20 mA, AKS32 (1 – 5 V) or AKS32R (10 – 90% ratiometric of 5 V supply voltage) Minimum and maximum pressure range Calibration value (+/- 5.0 bar)</p> <p>If you have used “Quick configurations” or “Wizard” to set up the controller, the inputs and outputs will be automatically set up (for additional information, see the “Quick configuration” or “Wizard” sections)</p> <p>Limitations: PWM outputs for digital scroll or stream compressors can only be selected on DO5 or DO6 Pressure transmitters with a current signal of 0 – 20 mA or 4 – 20 mA must be placed on analogue inputs AI1-AI4</p> <p><b>Note:</b> If a function has been connected to an input or output and is subsequently deselected in the configuration, the function in question will be marked with an exclamation mark (!). In this case, you must either activate the function in the configuration, or deselect the function on the input or output in question.</p>		
<p><b>Digital outputs</b></p> <p>1: 2: 3: 4: . . 8:</p>	<p><b>On/off outputs</b></p> <p>When a function that needs to use an output is defined, it will be possible to select this function on one of the available relay outputs.</p> <p>Select a relay and continue with the setting. In the last setting you will have the option of selecting the function you wish to connect to the relay and whether the function is to be active when the relay is activated or deactivated. Attention! Relay outputs must not be inverted at unloader valves. The controller inverts the function itself.</p> <p>There will be no voltage at the bypass valves when the compressor is not in operation. Power is connected immediately before the compressor is started.</p> <p>If it is a function that requires frequent switching between on/off (e.g. unloader on a scroll compressor, a Stream or a Bitzer CR11), use the solid state relay for this connection. There are solid state relays on output numbers 5 and 6.</p>	<p>On Off</p>
<p><b>Digital inputs</b></p> <p>1: 2: 3: . . 8:</p>	<p><b>On/off inputs</b></p> <p>When a function is defined that uses an input, it will be possible to select this function on one of the available on/off inputs.</p> <p>Select an input and continue on into the setting. In the final setting you will be able to select which function you wish to connect to the input.</p>	<p>On Off</p>
<p><b>Analog outputs</b></p> <p>1: 2: 3: 4:</p>	<p><b>0 – 10 V outputs</b></p> <p>When a function has been defined that needs to use a variable voltage outlet, it will be possible to select this function on one of the available AO outputs (AO 1-4 is available).</p> <p>Select one output and continue on in the setting process. In the last setting you will have the option of selecting which function you wish to link to the output.</p>	<p>0 – 10 V 0 – 5 V</p>
<p><b>Analog inputs</b></p> <p>1: 2: 3: 4: . . 8:</p>	<p><b>Analogue inputs</b></p> <p>When a function is defined that needs to use a temperature sensor or a pressure transmitter, it will be possible to select this function on one of the available AI inputs.</p> <p>Select an input and continue on into the setting. In the final setting you will be able to select which function you wish to connect to the input.</p> <p>Saux is a sensor for a general thermostat. (A type AKS 2050 pressure transmitter, for high pressure, emits a signal as an AKS 32R.)</p>	<p><i>Pressure signal:</i> AKS 33 AKS 32R AKS 32 2 – 10 V 0 – 20 mA 0 – 10 V 0 – 5 V</p> <p><i>Temperature signal:</i> NTC-86K Pt 1000 ohm None</p>

I/O Status			
	<b>Digital outputs</b> 1: . 8:	<b>Status of on/off outputs</b> Here you can see if the function is on or off.	
	<b>Digital inputs</b> 1: . 8:	<b>Status of on/off inputs</b> Here you can see the status of the function/alarm.	
	<b>Analogue outputs</b> 1: 2: 3: 4:	<b>Status of analogue outputs</b> Here you can see the size of the output signals as a % of max. signal.	
	<b>Analog inputs</b> 1: . 8:	<b>Status of analogue inputs</b> Here you can see pressure and temperature values received by the controller. The values include calibration	
	<b>I/O Summary</b> DO: Max 8, Used: __ DI: Max 8, Used: __ AO: Max 4, Used: __ AI: Max 8, Used: __	<b>Inputs and outputs used</b> Here you can see how many of the different inputs and outputs are available. You can also compare this amount with how many have been configured. If too many have been defined, an exclamation mark (!) will appear.	
I/O Manual control			
	<b>Digital outputs</b>	<b>Manual control of a relay output</b> Under normal regulation, the function of the relay will be in "Auto". In the event of an override, the function will be switched to either "On" or "Off". Remember to switch to "Auto" when the override is to be completed.	Auto / On / Off
	<b>Analog outputs</b>	<b>Manual control of analogue output</b> During normal regulation, the function of the output will be "Auto". In the event of an override, the function must first be changed to "Manual", after which the output signal can be changed from 0-100%. Remember to switch to "Auto" when the override is to be completed.	Auto / Man 0-100%
Alarm priorities			
	<b>General</b> Standby mode: Sensor error: Refrigerant: Output in MANUAL:	<b>Alarm priorities</b> The controller will issue an alarm notification if a specific incident occurs. Each incident is set to indicate the importance of each alarm, but it is possible to modify the importance of each. Choose from between the following priority levels: <b>Critical:</b> Important alarms that require a high level of attention. <b>Severe:</b> Alarms of intermediate importance <b>Normal:</b> No important alarms <b>Disable:</b> Alarms set to this priority level will be cancelled. Factory setting for the alarm can be seen on page 21.	Critical Severe Normal Disable
	<b>Suction group A</b> Low pressure: High pressure: Compressor safety:		
	<b>Suction group B</b> Low pressure: High pressure: Compressor safety:		
	<b>Condenser</b> High pressure: Fan safety:		

Quick setup								
<b>Quick configurations</b>	This setting will reserve inputs and outputs for the following compressors and fans: The various connections are shown on the next page.							
	<b>App. no.</b>	<b>Display</b>	<b>Suction group A</b>			<b>Suction group B</b>	<b>Condenser</b>	
			Speed	Digital (Scroll / steam)	1-step	1-step	Step	Speed
	17	3CDA + 2CB + FS		1	2	2		x
	16	2CDA + 2CB + 3F		1	1	2	3	
	15	3CSA + 2CB + FS	1		2	2		x
	14	2CSA + 2CB + 3F	1		1	2	3	
	13	4CA + 3CB + FS			4	3		x
	12	3CA + 2CB + FS			3	2		x
	11	2CA + 2CB + 3F			2	2	3	
	10	4CDA + FS		1	3			x
	9	3CDA + FS		1	2			x
	8	3CDA + 3F		1	2		3	
	7	2CDA + 2F		1	1		2	
	6	4CSA + FS	1		3			x
	5	4CA + FS			4			x
	4	4CA + 4F			4		4	
	3	3CSA + FS	1		2			x
	2	3CA + FS			3			x
	1	3CA + 3 F			3		3	
0	None	After making a selection, the setting will return to "None"						
	After making a selection you must: 1. Set the type of refrigerant 2. Check the types of pressure transmitters 3. Check the min. and max. settings on the pressure transmitters  Factory setting: Po A/B = AKS 32R, min=-1.0 bar, max.=12 bar Pc = AKS 32R, min. = -1.0 bar, max. = 34 bar SdA = NTC 86K							
<b>Setup Wizard</b>	This wizard will lead you through the necessary settings, i.e. a total of approximately 20 to 35 display screens, depending on what is selected along the way. The selection will also result in a connection to a given input and output. You yourself will see this connection in the IO configuration menu. If applicable, see page 20.							

### 8. Connections used in "Quick configurations"

App. no.	Display	Output										Input																
		On/Off					Analog					Analog					Digital											
		D01	D02	D03	D04	D05	D06	D07	D08	A01	A02	A03	A04	A11	A12	A13	A14	A15	A16	A17	A18	D11	D12	D13	D14	D15	D16	D17
17	3CDA + 2CB + FS	C1A	C2A	C3A	C1B	C1A	C1B	C1A	C1B	C1A	C1B	Fan Speed	PoA	PoB	Pc	Sc3	SdA Digi				C1A	C2A	C3A	C1B	C2B		Main Sw.	Fan safe.
16	2CDA + 2CB + 3F	C1A	C2A	C1B	C2B	C1A	Fan2	Fan3					PoA	PoB	Pc	Sc3	SdA Digi				C1A	C2A	C1B	C2B			Main Sw.	Fan safe.
15	3CSA + 2CB + FS	C1A	C2A	C3A	C1B	C2B	Fan VSD	Alarm				Fan Speed	PoA	PoB	Pc	Sc3					C1A	C2A	C3A	C1B	C2B		Main Sw.	Fan safe.
14	2CSA + 2CB + 3F	C1A	C2A	C1B	C2B	Fan1	Fan3	Alarm				C1A Speed	PoA	PoB	Pc	Sc3					C1A	C2A	C1B	C2B			Main Sw.	Fan safe.
13	4CA + 3CB + FS	C1A	C2A	C3A	C4A	C1B	C2B	C3B	Alarm			Fan Speed	PoA	PoB	Pc	Sc3					C1A	C2A	C3A	C4A	C1B	C2B	C3B	Fan safe.
12	3CA + 2CB + FS	C1A	C2A	C3A	C1B	C2B	Fan VSD	Alarm				Fan Speed	PoA	PoB	Pc	Sc3					C1A	C2A	C3A	C1B	C2B		Main Sw.	Fan safe.
11	2CA + 2CB + 3F	C1A	C2A	C1B	C2B	Fan1	Fan3	Alarm					PoA	PoB	Pc	Sc3					C1A	C2A	C1B	CB2			Main Sw.	Fan safe.
10	4CDA + FS	C1	C2	C3	C4	C1	Fan VSD	Alarm				Fan Speed	PoA		Pc	Sc3	SdA Digi				C1	C2	C3	C4			Main Sw.	Fan safe.
9	3CDA + FS	C1	C2	C3		C1	Fan VSD	Alarm				Fan Speed	PoA		Pc	Sc3	SdA Digi				C1	C2	C3				Main Sw.	Fan safe.
8	3CDA + 3F	C1	C2	C3	Fan1	Fan2	Fan3	Alarm					PoA	PoB	Pc	Sc3	SdA Digi				C1	C2	C3				Main Sw.	Fan safe.
7	2CDA + 2F	C1	C2	Fan1	Fan2	C1		Alarm					PoA	PoB	Pc	Sc3	SdA Digi				C1	C2					Main Sw.	Fan safe.
6	4CSA + FS	C1	C2	C3	C4		Fan VSD	Alarm				C1 Speed	PoA	PoB	Pc	Sc3					C1	C2	C3	C4			Main Sw.	Fan safe.
5	4CA + FS	C1	C2	C3	C4		Fan VSD	Alarm				Fan Speed	PoA	PoB	Pc	Sc3					C1	C2	C3	C4			Main Sw.	Fan safe.
4	4CA + 4F	C1	C2	C3	C4	Fan2	Fan3	Fan4					PoA	PoB	Pc	Sc3					C1	C2	C3	C4			Main Sw.	Fan safe.
3	3CSA + FS	C1	C2	C3			Fan VSD	Alarm				C1 Speed	PoA	PoB	Pc	Sc3					C1	C2	C3				Main Sw.	Fan safe.
2	3CA + FS	C1	C2	C3			Fan VSD	Alarm				Fan Speed	PoA	PoB	Pc	Sc3					C1	C2	C3				Main Sw.	Fan safe.
1	3CA + 3F	C1	C2	C3	Fan1	Fan2	Fan3	Alarm					PoA	PoB	Pc	Sc3					C1	C2	C3				Main Sw.	Fan safe.
0	None																											

**Example of display view:**  
**3CDA + 2CB + FS = 3 compressors, one is digital, suction group A + 2 compressors, suction group B + one fan, are speed-controlled**

### Connections when using Setup Wizard

If you have used the Setup Wizard for the configuration, the controller will automatically assign the selected functions to inputs and outputs in accordance with the following prioritised order:

#### Digital outputs (DO1-DO8):

- Pulse output for control of the capacity valves for digital scroll, stream or Bitzer CR11 will be located on solid state outputs DO5 and DO6
- Compressor start and unloaders for suction groups A and B, respectively
- Fans
- Injection ON
- Alarm

#### Digital inputs (DI1-DI8):

- Compressor safety inputs for suction groups A and B, respectively
- Fan safety input
- External main switch (start/stop)
- HP safety switch
- LP safety switch for suction groups A and B, respectively
- Night status
- Heat recovery
- Load shedding
- General alarm inputs DI1-DI3

#### Analogue outputs (AO1-AO4)

- Compressor speed control for suction groups A and B, respectively
- Condenser speed control

#### Analogue inputs (AI1-AI8)

- PoA and PoB suction pressure is located on AI1 and AI2, respectively
- Pc condensation pressure is located on AI3
- Sc3 outside temperature is located on AI4
- S4A and S4B media temperature
- S7 media temperature, condenser
- Sd comp. 1 discharge gas temperature for digital scroll/stream compressor for suction groups A and B, respectively
- Ss suction gas temperature for section groups A and B, respectively
- Sd discharge gas temperature for suction groups A and B, respectively
- Saux for general thermostat

The assignment of functions on the respective inputs and outputs can be regulated in "IO configuration". Here is an example of 3 compressors and 3 fans:

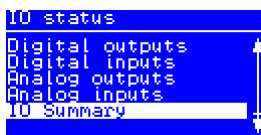
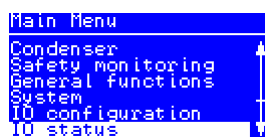
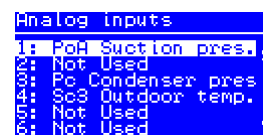
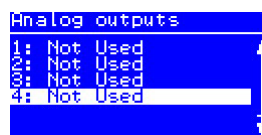
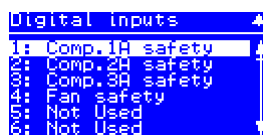
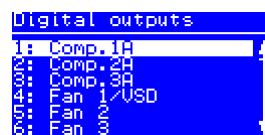
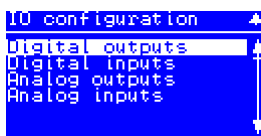
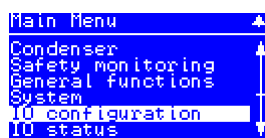

In this image you can see how many outputs and inputs your settings have provided.

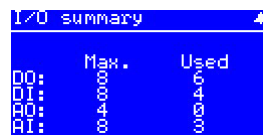

## 9. Alarm list

Alarm text	Reason	Priority setting	Default value
<b>General alarms</b>			
Standby mode (Main sw. OFF)	Alarm when control is stopped by internal or external Main Switch (DI input "Main Switch")	Standby mode	Normal
PoA sensor error	Pressure transmitter signal from PoA defective	Sensor error	Normal
PoB sensor error	Pressure transmitter signal from PoB defective		
S4A sensor error	Temperature signal from S4A media temp. sensor defective		
S4B sensor error	Temperature signal from S4B media temp. sensor defective		
SsA sensor error	Temperature signal from SsA suction gas temp. defective		
SsB sensor error	Temperature signal from SsB suction gas temp. defective		
SdA sensor error	Temperature signal from SdA discharge gas temp. Sd defective		
SdB sensor error	Temperature signal from SdB discharge gas temp. Sd defective		
Pc sensor error	Pressure transmitter signal from Pc defective		
S7 sensor error	Temperature signal from S7 media sensor on condenser defective		
Sc3 sensor error	Temperature signal from Sc3 air on condenser defective		
Sd Comp. 1A sensor error	Temperature signal from "Sd comp. 1A" discharge gas temp. on digital scroll/Stream compressor is defective		
Sd Comp. 1B sensor error	Temperature signal from "Sd comp. 1B" discharge gas temp. on digital scroll/Stream compressor is defective		
Saux - sensor error	Temperature signal from Saux thermostat sensor is defective		
Refrigerant not selected	Alarm if no refrigerant has been selected	Refrigerant not set	Normal
Output in manual mode	An output is set in manual mode	Output in MAN mode	Normal
IO configuration error	Not all inputs and output functions have been assigned to hardware Inputs or outputs*	(can not be set)	Normal
GA1 - "Alarm text"	Alarm on general alarm input DI 1 (DI input "Gen. Alarm 1 - alarm text depend upon configured text)	General alarm 1	Normal
GA2 - "Alarm text"	Alarm on general alarm input DI 2 (DI input "Gen. Alarm 2 - alarm text depend upon configured text)	General alarm 2	Normal
GA3 - "Alarm text"	Alarm on general alarm input DI 3 (DI input "Gen. Alarm 3 - alarm text depend upon configured text)	General alarm 3	Normal
<b>Suction A alarms</b>			
PoA Low suction pressure	Minimum safety limit for suction pressure PoA has been violated	Low pressure PoA	Normal
LP A safety switch cut out	Low safety limit for external low pressure switch has been violated (DI input "LP switch A")		
PoA High suction pressure	High alarm limit for PoA has been exceeded	High pressure PoA	Critical
SsA High superheat	Superheat in suction line A too high (measured by PoA and SsA)	Superheat A	Normal
SsA Low superheat	Superheat in suction line A too low (measured by PoA and SsA)		
SdA High discharge temp.	Safety prevention limit for SdA discharge temperature has been exceeded (10K below safety limit)	High disch. temp.SdA	Critical
Comp. 1A High disch. temp	Safety limit for discharge gas temperature of digital scroll/Stream/CRII compressor has been exceeded	Compressor safety A	Normal
Compressor 1-8A safety cut out	Compressor no. 1-8 A has been cut out on general safety input (DI input "Comp.1-8 A safety")		
<b>Suction B alarms</b>			
PoB Low suction pressure	Minimum safety limit for suction pressure PoB has been violated	Low pressure PoB	Normal
LP B safety switch cut out	Low safety limit for external low pressure switch has been violated (DI input "LP switch B")		
PoB High suction pressure	High alarm limit for PoB has been exceeded	High pressure PoB	Critical
SsB High superheat	Superheat in suction line B too high (measured by PoB and SsB)	Superheat B	Normal
SsB Low superheat	Superheat in suction line B too low (measured by PoB and SsB)		
SdB High discharge temp.	Safety prevention limit for SdB discharge temperature has been exceeded (10K below safety limit)	High disch. temp.SdB	Critical
Comp. 1B High disch. temp	Safety limit for discharge temperature of digital scroll/Stream compressor has been exceeded	Compressor safety B	Normal
Compressor 1-4B safety cut out	Compressor no. 1-4 B has been cut out on general safety (DI input "Comp.1-4 B safety")		
<b>Condenser alarms</b>			
Pc High condensing pressure	High prevention safety limit for condensing pressure Pc has been violated (3K below safety limit)	High pressure Pc	Critical
HP safety switch cutout	High safety limit for external high pressure switch has been violated (DI input "HP switch")		
Common fan safety cut out	A Fan is reported defective via common safety input (DI input "Fan safety")	Fan safety	Normal
Fan 1 safety cut out	Fan no. 1-8 is reported defective via individual safety input (DI input "Fan 1-8 safety")		

\* The alarm "IO configuration error" is activated if not all IO functions have been assigned to a hardware Input or output.

Often the reason is that too many functions have been selected via the configuration of the controller.

Go to the menu point "Main menu => IO status => IO summary".

In this screen you can see if you have configured too many functions of a certain type - indicated by an exclamation mark "!"

Please refer to the screen example, were too many DO functions have been configured.

Solve the problem by adapting the DO functions to the max. No of DO outputs.

I/O summary		
	Max.	Used
DO:	0-4-00000	1000000
DI: †		1000000
PO:		0000000
AI:		0000000

### Sensor alarms

Sensor alarms shut off automatically when the sensor has been O.K. for 10 minutes.

If you have corrected the sensor error and want to perform a manual, forced removal of the alarm, go to the "Alarm detail display"

Press and hold the "X" key for 2 seconds here.

**ERR31**
**Alarm on the external display - MMIGRS2**

If the communication to the display is not carried out correctly, it will send an "ERR31" error notification. This may be caused by the displayed terminations not being installed, or that there have been interruptions in data communication during the time when the display retrieves the basic information from the controller. Once the terminations have been inspected, you should then check the software version of the external display. This is done by holding down the Enter key and the X key for 5 seconds, until the Bios menu appears. Next, press the X key and read off the software version in the bottom right corner. The software version must be 1.13 or newer.

Once the display's software version has been checked, check the display's settings as follows:

1. Hold the Enter key and the X key down for 5 seconds, until the Bios menu appears.
2. Select the "MCX selection" menu
  - Select the "Clear UI" line and press Enter
  - Select the "Autodetect" line and press Enter
3. Select the "COM selection" menu
  - Select the "CAN" line and press Enter
4. Select the "Start up mode" menu
  - Select the "Remote application" line and press Enter
5. Select the "CAN" menu
  - Select the "Baudrate" line and then select the "Autobaud" setting and press Enter
  - Select the "Node ID" line and set the value to 126 and press Enter
6. Press the X key to return to the Bios menu
7. Select the "Application" menu and press Enter. "Data" will be shown.

The display will once again retrieve data from the controller. This process will take upto 5 min.

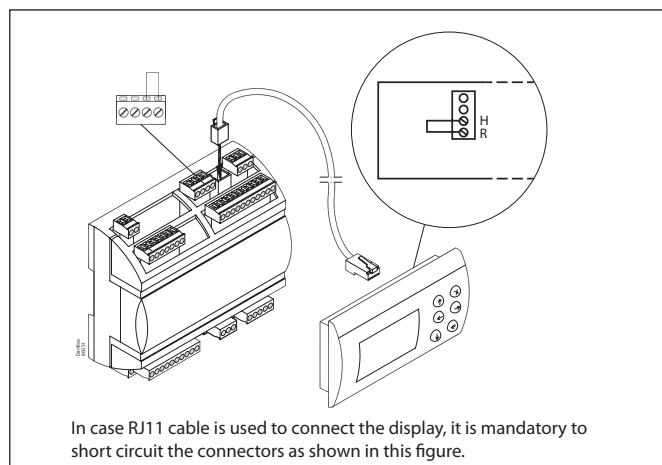



## 10. Connections

### Connection, lower level

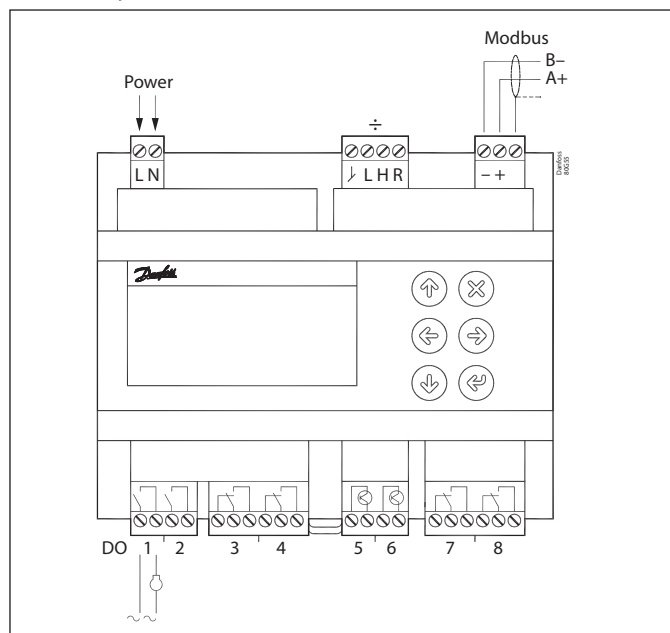

DO	DO1	DO2	DO3	DO4	DO5	DO6	DO7	DO8	Σ 1-8
<b>I Max.</b>	10 A (3.5)	10 A (3.5)	6 A (4)	6 A (4)	0.5 A min. 50 mA loff < 1,5 mA	0.5 A min. 50 mA loff < 1,5 mA	6 A (4)	6 A (4)	32 A
<b>U</b>	<b>All 24 V or all 230 V AC</b>								

### Supply Voltage.

The supply voltage is either 24 V or 110 – 230 V. See the label on the reverse side of the controller.

### ÷ = Plugs normally not used

However, if connecting to an external display, a jumper must be inserted between the connections "H" and "R".

### Modbus

It is important that the installation of the data communication cable be done correctly. Cf. separate literature No. RC8AC. Remember termination at the bus termination.

### DO - Digital outputs, 8 pcs. DO1 - DO8

DO5 and DO6 are solid state relays.

The relays are de-rated to the specified values.

If an alarm relay is defined, it will be driven under normal operation and it will drop in the event of alarms and insufficient power to the controller.

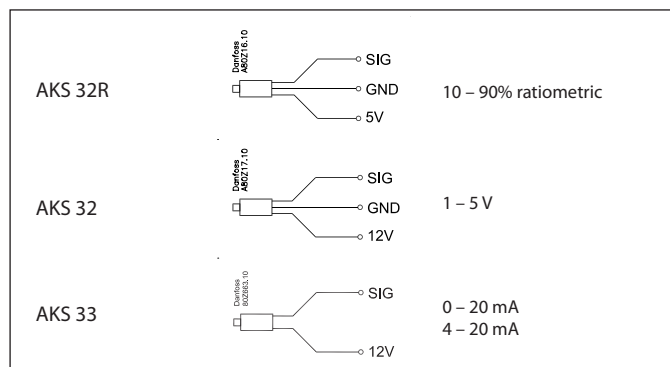

### Connection, upper level

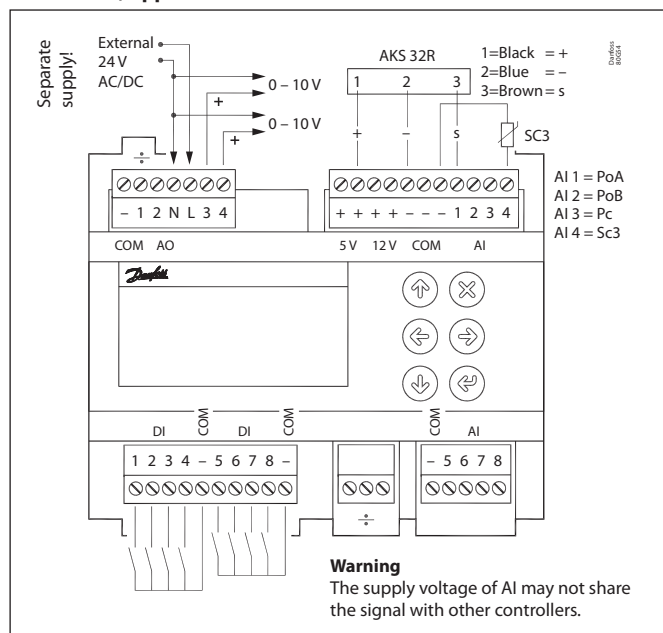

### Electric noise

Signal cables for sensors, DI inputs, data communication and display must be kept separate from high voltage (230 V) electric cables:

- Use separate cable trays
- Keep a distance between high voltage and signal cables of at least 10 cm
- Cables longer than 3 m at the DI input should be avoided

### AO - Analogue output, 4 pcs. AO1 - AO4

Must be used when using a frequency converter or EC motors. Connect 24 V on N and L only on AO3 and AO4 outputs (external supply). Avoid earth fault current. Use double-insulated transformer. The secondary side must not be earthed. Obtain 0 – 10 V from terminals N and AOx PAY ATTENTION TO THE POLARITY of N.

### AI - Analogue inputs, 4 pcs. AI1 - AI4

*Pressure transmitters*

- Ratiometric: 10 – 90% of supply, AKS 32R
- Signal: 1 – 5 V, AKS 32
- Power: 0 – 20 mA / 4 – 20 mA, AKS 33 (supply = 12 V)

*Temperature sensor*

- Pt 1000 ohm, AKS 11 or AKS 21
- NTC 86K ohm @ 25 °C, from digital scroll

*Factory settings*

AI1=PoA, AI2=PoB, AI3=Pc, AI4=Outdoor temperature SC3.

### DI - Digital switch inputs, 8 pcs. DI1 - DI8

The connection may be a shut-down or interruption function. Select what is to be activated during configuration.

### ÷ = Plugs normally not used

### AI - Analogue inputs, 4 pcs. AI5 - AI8

*Pressure transmitters*

- Ratiometric: 10 – 90% of supply, AKS 32R
- Signal: 1 – 5 V, AKS 32

*Temperature sensor*

- Pt 1000 ohm, AKS 11 or AKS 21.
- NTC 86K ohm @ 25 °C, from digital scroll

### The capacity from the digital scroll compressor

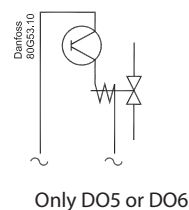
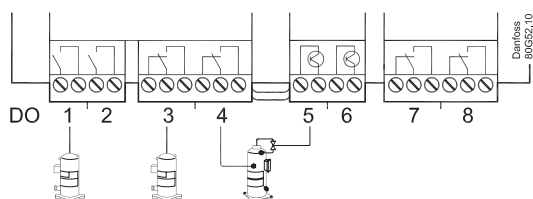

The capacity is divided into period times as "PWM period time". 100% capacity is delivered when cooling takes place for the whole period. An off time is required by the bypass valve within the period and an on time is also permitted. There is "no cooling" when the valve is on.

The controller itself calculates the capacity needed and will then vary it according to the cut-in time of the capacity control valve. A limit is introduced if low capacity is needed so that the cooling does not go below 10%. This is because the compressor can cool itself. This value can be increased if necessary.

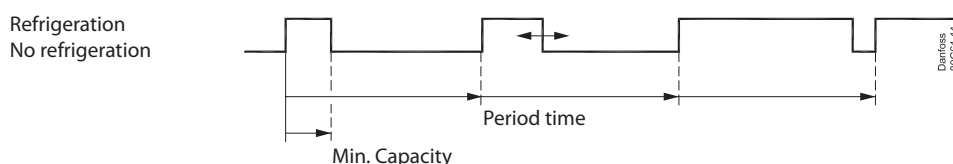

### Copeland Stream compressor

The pulse signal can also be used to control one stream compressor with one unloader valve \*(4 cylinders version). The compressor capacity is distributed by up to 50% for one relay and the remaining 50-100% for the unloader. The unloader is connected to DO5 or DO6.

### Bitzer CR11

The pulse signal can also be used to control one of the CR11 with 2 unloaders (4 cylinders version). Compressor capacity can be controlled from 10 – 100% depending on the pulsation of the unloaders. The unloaders are connected to DO5 and DO6.

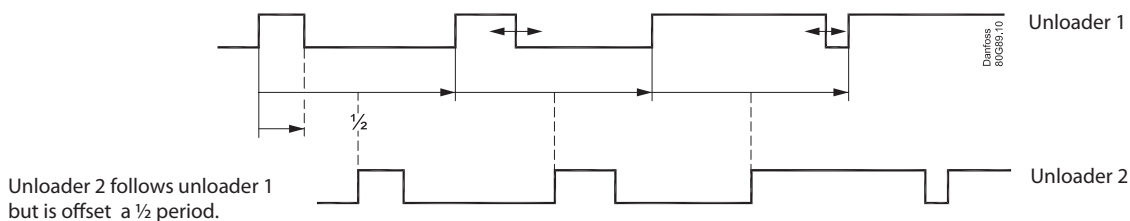

### Sd monitoring

When regulating with Sd monitoring, one of the three compressor types will increase capacity if the temperature nears the Sd limit. This will result in better cooling of the unloaded compressor.

### Injection off

The electronic expansion valves in the cooling appliances must be closed when all the compressors are prevented from starting. As a result, the evaporators will not be filled with fluid that can be led to a compressor when the regulation process restarts. One of the compressor control relays can be used for this function, or the function can be prompted via data communication.

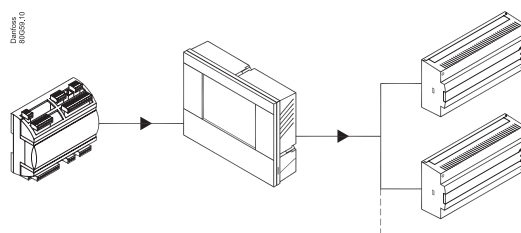
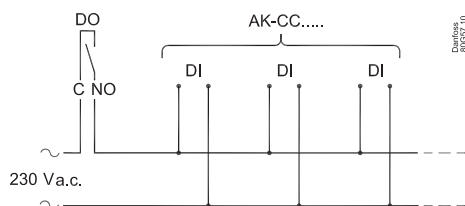

**11. Data**

Supply voltage	24 V AC +/-15% 50/60 Hz, 17 VA 24 V DC (20 – 60 V), 17 VA 230 AC (85 – 265 V) 50/60 Hz, 20 VA	
8 analog Input	Pressure measuring: Ratiometric pressure transmitter type AKS 32R 1 – 5 volt pressure transmitter type AKS 32 0 – 20 (4 – 20) mA pressure transmitter type AKS 33  Temperature measurement Pt 1000 ohm/0°C NTC - 86K from digital scroll / stream	
8 digital input	From contact function E.g. to: Start/stop of regulation Monitoring of safety circuits General alarm function	
Relay output to capacity control	4 pcs. SPDT (8A)	AC-1: 6 A (ohmic) AC-15: 4 A (inductive)
	2 pcs. SPST (16A)	AC-1: 10 A (ohmic) AC-15: 3.5 (inductive)
	2 pcs. Solid State. PWM for scroll - unload	I <sub>max.</sub> = 0.5 A I <sub>min.</sub> = 50 mA. Leak < 1.5 mA Not short-circuit protected
4 Voltage output	0 – 10 V DC, R <sub>i</sub> = 1kohm Separate 24 V supply required	
Display output	For type MMIGRS2	
Data communication	Modbus for AK-SM 800	
Environments	-20 – +60 °C, During operations	
	-40 – +70 °C, During transport	
	20 – 80% Rh, not condensed No shock influence / vibrations	
Enclosure	IP 20	
Weight	0,4 kg	
Mounting	DIN-rail	
Connection terminals	max. 2.5 mm <sup>2</sup> multi core	
Approvals	EU Low Voltage Directive and EMC demands re CE-marking complied with LVD tested acc. EN 60730-1 and EN 60730-2-9 EMC-tested acc. EN61000-6-2 and 3 UL approval	

**Pressure transmitter / temperature sensor**

Kindly refer to catalogue RK0YG...

**Capacitive load**

The relays are not suitable for the direct coupling of the capacitive loads such as LED and on / off control of EC motors.

All loads with a switch mode power supply has to be connected with a suitable contactor or the like.

**12. External display**

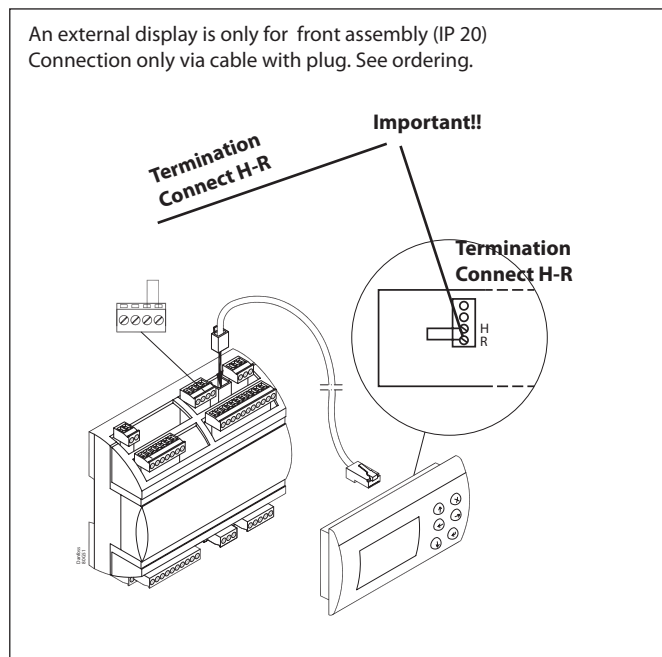
 An external display is only for front assembly (IP 20)  
Connection only via cable with plug. See ordering.

### 13. Ordering

Type	Function	Operation	Supply voltage	Code no.
AK-PC 551	Capacity controller		230 V	<b>080G0281</b>
			24 V	<b>080G0283</b>
			230 V	<b>080G0282</b>
			24 V	<b>080G0288</b>
MMIGRS2	Display unit		-	<b>080G0294</b>
	Wire for display unit			<b>080G0075</b>
	Wire for display unit			<b>080G0076</b>

### 14. Mounting /Dimensions

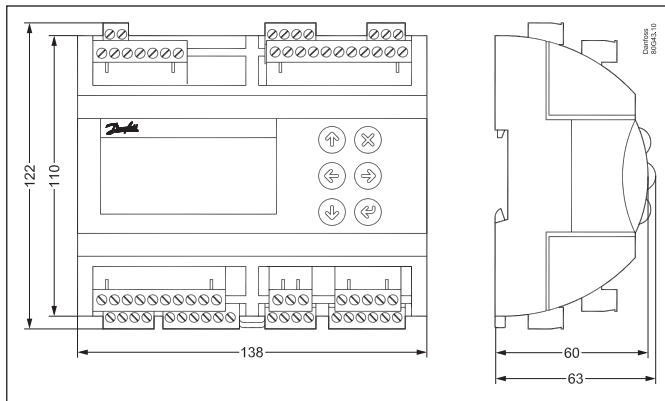

For DIN rail mounting only (IP 20)

#### Installation considerations

Accidental damage, poor installation, or site conditions, can give rise to malfunctions of the control system, and ultimately lead to a plant breakdown.

Every possible safeguard is incorporated into our products to prevent this. However, a wrong installation, for example, could still present problems. Electronic controls are no substitute for normal, good engineering practice.

Danfoss will not be responsible for any goods, or plant components, damaged as a result of the above defects. It is the installer's responsibility to check the installation thoroughly, and to fit the necessary safety devices.

Special reference is made to the necessity of signals to the controller when the compressor is stopped and to the need of liquid receivers before the compressors.

Your local Danfoss agent will be pleased to assist with further advice, etc.

#### List of literature

Installation guide for extended operation RC8AC

Here you can see how a data communication connection to ADAP-KOOL® Refrigeration control systems can be established.

#### Danfoss A/S

Climate Solutions • danfoss.com • +45 7488 2222

Any information, including, but not limited to information on selection of product, its application or use, product design, weight, dimensions, capacity or any other technical data in product manuals, catalogues descriptions, advertisements, etc. and whether made available in writing, orally, electronically, online or via download, shall be considered informative, and is only binding if and to the extent, explicit reference is made in a quotation or order confirmation. Danfoss cannot accept any responsibility for possible errors in catalogues, brochures, videos and other material. Danfoss reserves the right to alter its products without notice. This also applies to products ordered but not delivered provided that such alterations can be made without changes to form, fit or function of the product.

All trademarks in this material are property of Danfoss A/S or Danfoss group companies. Danfoss and the Danfoss logo are trademarks of Danfoss A/S. All rights reserved.